

LED visual and audio modular indicators

1

Montaggio / Mounting

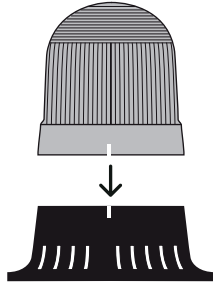

1° STEP

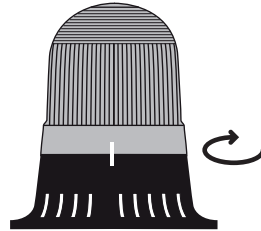

2° STEP

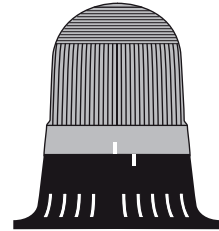

3° STEP

ITA - SEGNALATORI LUMINOSI E ACUSTICI MODULARI

I segnalatori luminosi e acustici sono destinati esclusivamente ad un impiego su macchine operatrici o sui relativi quadri di comando, per fornire agli operatori segnali di pericolo e allarme.

COME MONTARE IL SEGNALATORE

Innestare il settore di segnalazione sulla base facendo coincidere le tacche di riferimento e ruotare in senso orario fino allo scatto di arresto.

FR - SIGNALISATION LUMINEUSE ET SONORE

Les signalisations lumineuses et sonores sont exclusivement destinées à une utilisation sur machine ou sur armoire de commande pour signaler un danger ou une information à l'opérateur.

MONTAGE DE LA SIGNALISATION

Monter les secteurs lumineux et sonores sur l'embase en faisant correspondre les repères. Tourner dans le sens horaire pour verrouiller.

EN - VISUAL AND AUDIO MODULAR INDICATORS

The T.E. range of visual and audio indicators are exclusively designed to be installed on machines or their control panels, to communicate danger and warning signals to the machine operators.

MOUNTING

To connect a signal unit to base, align guiding marks and twist clockwise till they click locked.

DE - OPTISCHE UND AKUSTISCHE SIGNALGERÄTE

Optische und akustische Signalgeräte auf Arbeitsmaschinen oder ihre Schalttafeln dienen dazu, ihren Bedienern sowohl Beachtungs- als auch Gefahrensignale anzuzeigen.

Aufbau der Signalsäulen

Das Signalelement ist so auf den Fuß zu setzen, daß die Markierungen übereinstimmen, und im Uhrzeigersinn zu drehen, bis sie fest miteinander verbunden sind.

2

Abbinamenti / Combination



AA
85-A0/S

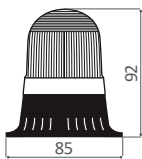

AF
85-A0/S

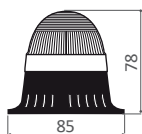

85-A0/S

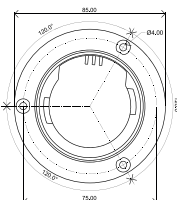

AA
85-B0/S

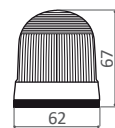

AF
85-B0/S

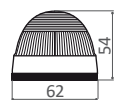

85-B0/S

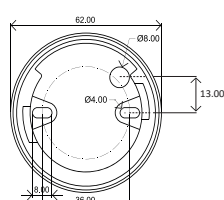

AA
85-C0/S

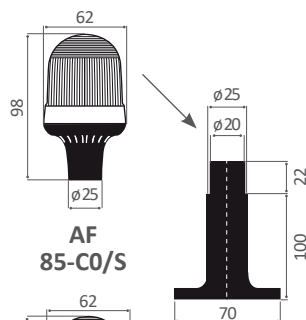

AF
85-C0/S

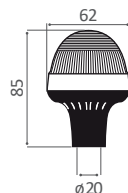

54-10

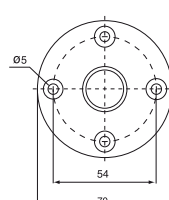

AA
85-D0/S

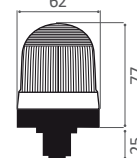

AF
85-D0/S

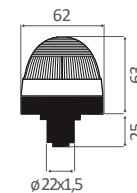

85-D0/S

Ø 22,3



AA
85-E0/S

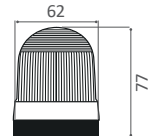

AF
85-E0/S

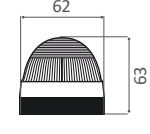

85-E0/S

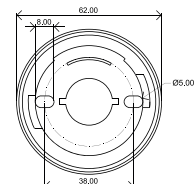

Power supply / alimentazione

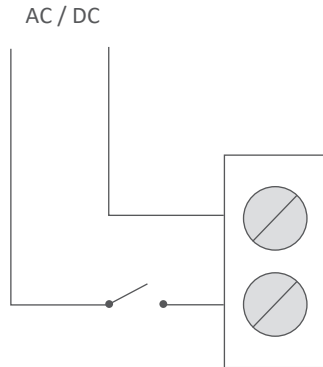

Terminal / Morsettieria di sicurezza

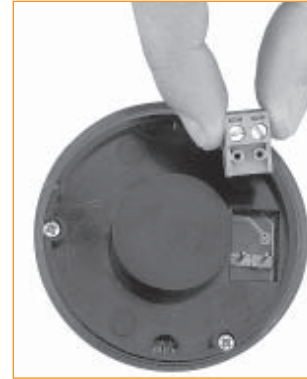

ITA - COLLEGAMENTI

Attenzione !! prima di eseguire qualsiasi tipo di lavoro deve essere tolta la tensione. Verificare la tensione di funzionamento dei segnalatori! Una tensione troppo alta provoca danni! L'installazione deve avvenire a cura di personale specializzato. Collegarsi alla morsettieria come da schema. I segnalatori vanno alimentati con trasformatori di sicurezza secondo le norme vigenti.

MANUTENZIONE

Deve essere controllata periodicamente l'efficienza dei segnalatori luminosi e di quello acustico, come previsto dalle norme vigenti. Prima di eseguire qualsiasi intervento di manutenzione deve essere tolta la tensione. In caso di guasto sostituire il settore di segnalazione completo.

Per smontare i settori di segnalazione ruotare in senso antiorario ed estrarre. Pulire il segnalatore luminoso e acustico con detergente non aggressivo; non utilizzare solventi.

LIMITI DI IMPIEGO

Utilizzare il prodotto secondo le prescrizioni previste in questo foglio informativo e nell'apposito prospetto tecnico.

FR - RACCORDEMENT

Attention : toute intervention doit être effectuée hors tension ! Respecter la tension assignée des éléments de signalisation ! Une tension trop élevée entraîne des dégâts ! L'installation doit être effectuée par personnel spécialisé. Raccorder les bornes. Les signalisations doivent être alimentées avec transformateurs de sûreté selon les normes en vigueur.

ENTRETIEN

Contrôler régulièrement le fonctionnement de la signalisation en fonction de la norme en vigueur.

Attention : toute intervention doit être effectuée hors tension !

Démonter en tournant dans le sens anti-horaire.

Ne pas utiliser du solvant pour le nettoyage.

LIMITES D'EMPLOI

Ce produit doit être utilisé selon les prescriptions décrites sur ce document.

EN - CONNECTIONS

WARNING!! Before carrying out any operation, always check that the power is switched off. It is important to check the rated voltages of the signalling devices! Excessively high voltage will cause damage! The installation must be carried out by specialized personnel. Connect to terminals. Visual and audio indicators must be powered with security transformers according the norms in force.

MAINTENANCE

WARNING!! Before starting any maintenance work, always check that the power is switched off. Check efficiency of each visual or audio indicator unit installed, as foreseen in current regulations. To unfasten signal units, twist anticlockwise, and pull it upwards. To clean signal units always use a mild detergent. Never use any form of solvents.

LIMITATIONS

Always use indicators in accordance with current regulations, together with the recommendations listed in these instructions and the data contained in our technical Catalogue.

DE - Anschluß

Die Installation muss unbedingt von Fachkräfte gemacht werden.

Vorsicht!! Vor Ausführung jeglicher Arbeiten muß die Spannung stets abgeschaltet werden. Mit dem Schraubanschluß verbinde. Die Signalgeräteeinheiten müssen mit Sicherheitstrafos, nach geltenden Normen, versorgt sein.

Wartung

In Abständen ist die Wirksamkeit der Signalgeräte gemäß der gültigen Normen zu überprüfen.

Vor Ausführung jeglicher Arbeiten muß die Spannung stets ausgeschaltet werden. Zum Abbau der Signalelemente sind diese gegen den Uhrzeigersinn zu drehen und abzuziehen. Entfernung von Schmutz durch milde Reinigungsmittel. Keine Lösungsmittel verwenden.

Verwendung

Die Produkte dürfen nur gemäß den Hinweisen dieser Anleitung sowie des technischen Kataloges verwendet werden.

LED Steady light
Luce fissa LED

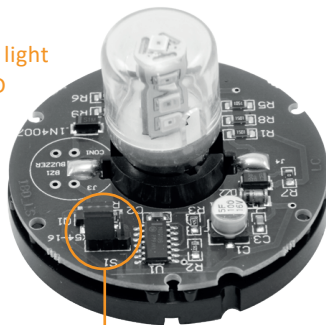

LED Flashing light
Luce lampeggiante LED

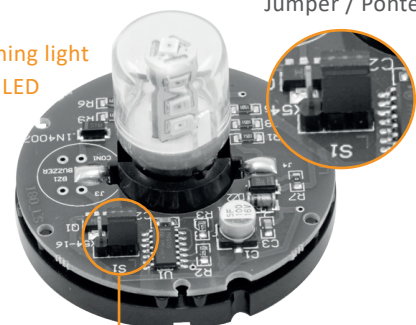

Per cambiare la funzione, spostare il ponticello.
To change the function, shift the jumper inside.